

ARKIVE\_EFFECTS\_

# *The Dust Collector*

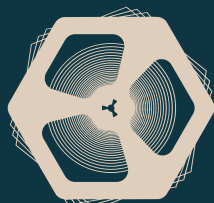

User's Manual  
Version 1.3  
June 2023

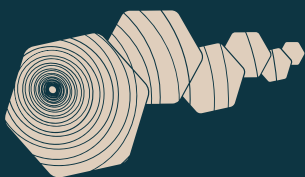
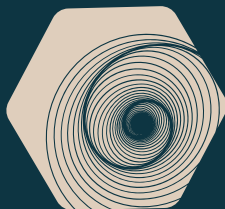
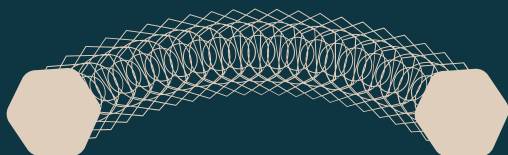

FINEGEAR

# INDEX

- Introduction – 3**
- Overview – 4**
  - Top – 4
  - Side – 5
  - Back – 5
- Effects – 6**
  - LFOs 1 & 2 – 6
  - Tape Saturations 1 & 2 – 7
  - Spring Reverb – 8
  - Delay – 9
  - Phaser – 10
- Signal Paths – 11**
  - LFOs – 11
  - Tape Saturations – 11
  - Spring Reverb – 11
  - Delay – 12
  - Phaser – 12
- Specifications – 13**
  - Conventions – 13
  - Technical details – 13
  - Dimensions – 13
  - Weight – 13



# INTRODUCTION

**Finegear is proud to present ARKIVE\_EFFECTS\_: a curated series of effects designed for sonic experimentation.**

***The Dust Collector* is the first of the series, aiming to honor and expand upon the history of experimentation in music, shaking some of the dust that has settled on the 1970's.**

***The Dust Collector*** contains 2 VC LFOs and 5 independent audio effects: 2 Tape saturations, a Spring reverb, a Delay and a Phaser. However, this is more than the standard multi-effect box, as each module has been analyzed and tweaked to support your creative process. You can go further inside with several moddable features directly on the PCB.

My aim, and the goal of this manual, is to help you uncover unique sounds and new uses for effects you thought you knew. You can insert an effect in the Delay's feedback loop, add modulation to the Phaser (as well as to pretty much every other effect), poke the tank's three springy insides hiding behind the removable acrylic cover, and so much more.

This manual will describe in detail each effect and module, as well as explain all the controls and interactions that are possible with them. Useful technical information is also provided, while signal path diagrams can be found in the annexes.

Enjoy!

Cristian



# OVERVIEW

## Top

- 1 2x VC LFOs
- 2 2x Tape saturations
- 3 Spring reverb
- 4 Delay
- 5 Phaser
- 6 Reverb spring tank, with a removable plexi cover

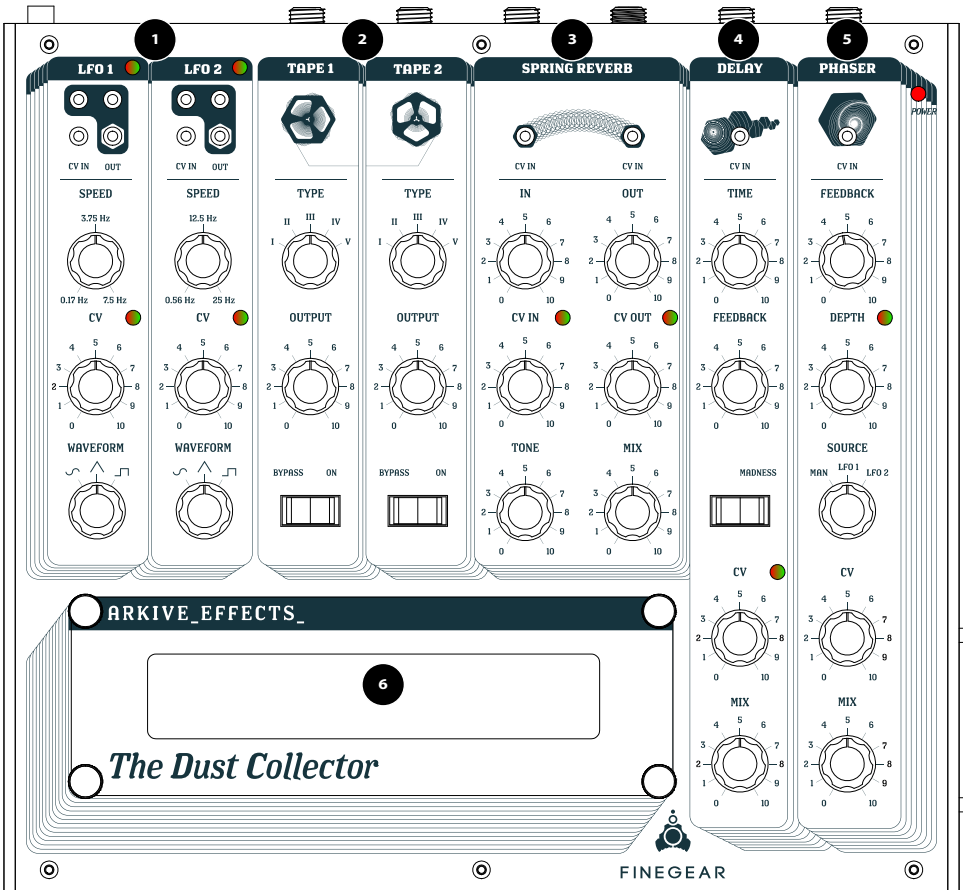

# OVERVIEW

## Side (left)

- 7 Phaser LDR with removable plexi cover, attached with 4 hex screws

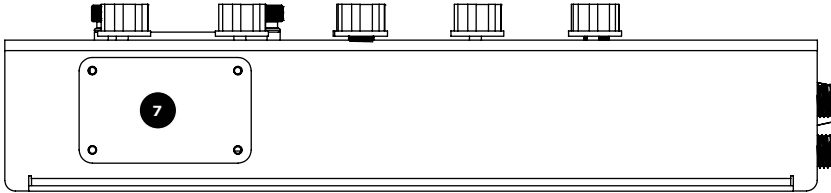

## Back

- 1 Phaser input and output
- 2 Delay input and output
- 3 Delay feedback loop insert
- 4 Spring reverb input and output
- 5 Tape Saturation 2 input and output
- 6 Tape Saturation 1 input and output
- 7 Power supply connector (5 mm diameter, 2.5 mm pin)
- 8 Power switch

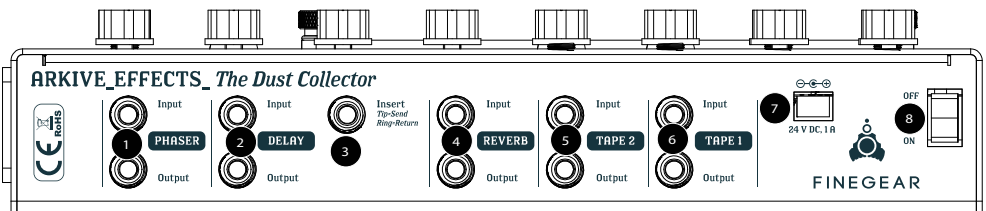

**Note:**

Unless indicated otherwise, all inputs, outputs, and inserts require 6.5 mono jacks.



# EFFECTS

## LFOs 1 & 2

The two LFOs included in *The Dust Collector* are identical, except for their speed ranges, as a way to extend the sonic possibilities.

They were included to serve as a starting point for modulating any of the effects, including the LFOs themselves, even without a modular setup (and especially if one is not available).

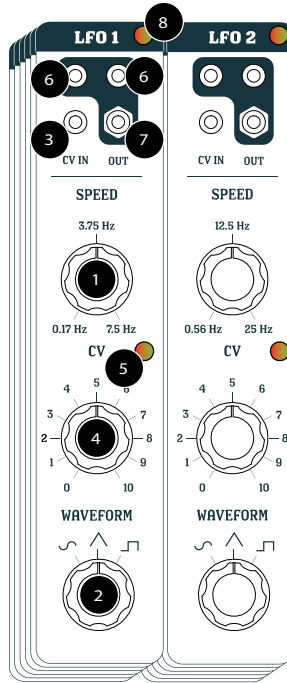

### 1 Speed:

Sets the speed of the LFO. The two LFOs have different ranges in order to allow as many modulation combinations as possible.

### 2 Waveform selector:

Selects the output waveform between sine, triangle and square.

### 3 Speed modulation CV input

Input for modulating the speed of the LFO using a CV (3.5 mm jack).

### 4 Speed CV modulation amount

Sets the amount of modulation from the CV input (3) that will affect the LFO's speed.

### 5 Speed CV modulation indicator

Bi-colour LED providing visual feedback of the CV input's (3) value.

### 6 CV outputs 1 & 2

Two identical LFO outputs.

### 7 Inverted CV output

Outputs the inverted LFO using a CV (3.5 mm jack).

### 8 Output bi-colour LED indicator

Bi-colour LED providing visual feedback of the LFO's output value.



# EFFECTS

## Tape Saturations 1 & 2

The two “tape” saturations are included to help spice or dirty up sounds before or after passing through the other effects.

The saturation effect ranges from very subtle (type I) to more saturated and compressed (type V).

For *The Dust Collector*, this effect is achieved through analog electronics entirely, without any actual tapes.

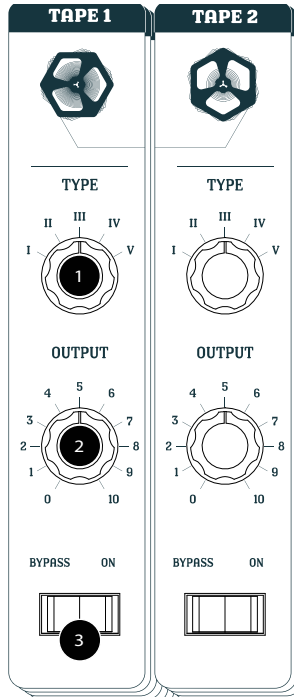

**1 Type:**

Sets the type, i.e. the intensity of the saturation effect. The further the type knob is turned to the right, the more pronounced the effect.

**2 Output volume:**

Sets the output gain.

**3 Bypass switch:**

Bypasses the effect.

**DIY tip:** The schematics for the Tape Saturations are based on five pairs of diodes. *The Dust Collector* uses one pair of 1N4148 and four pairs of 1N60 diodes. Different diode models can be mixed and matched for (slightly) different saturation effects.



# EFFECTS

## Spring Reverb

Besides having the classic spring tank sound, the spring reverb was integrated to allow extensive interaction:

- Direct physical interaction with the springs, thanks to the removable plexi cover;
- Extended modularity, thanks to input and output CV controllable VCAs.

### 1 Input VCA level:

Sets the input VCA's level.

### 2 Input VCA modulation CV input:

Input for modulating the input VCA with a CV (3.5 mm jack).

### 3 Input VCA CV modulation amount:

Sets the amount of modulation from the CV input (2) that will affect the input VCA.

### 4 Input VCA CV modulation indicator:

Bi-colour LED providing visual feedback of the input VCA's CV input's (2) value.

### 5 Output VCA level:

Sets the output VCA's level.

### 6 Output VCA modulation CV input:

Input for modulating the output VCA with a CV (3.5 mm jack).

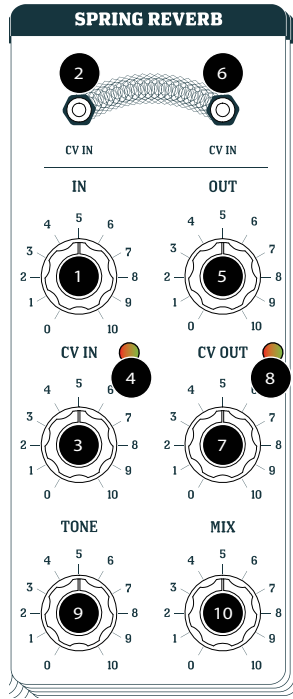

### 7 Output VCA CV modulation amount:

Sets the amount of modulation from the CV input (6) that will affect the input VCA.

### 8 Output VCA CV modulation indicator:

Bi-colour LED providing visual feedback of the output VCA's CV input's (6) value.

### 9 Tone control:

Sets the tone of the signal before the output VCA and after the signal is amplified by the recovery amp.

Tone control is obtained thanks to a shelving filter: to the left, the bass frequencies are amplified and the treble is reduced, while to the right, the treble is amplified and the bass is reduced.

### 10 Dry/wet mix:

Sets the balance between the input signal (dry/clean) and the output signal (wet/processed).

### 11 Removable cover:

The spring tank has a transparent plexi cover. Remove it using the thumb screws, to scratch, hit, rub, place various objects on the springs... Be creative!

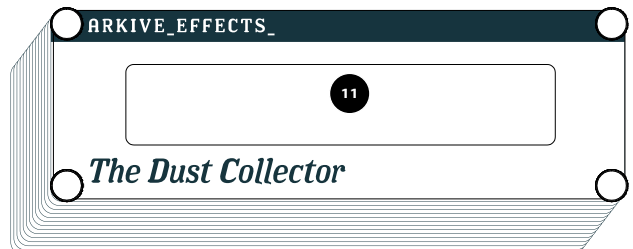



# EFFECTS

## Delay

The included delay takes pride in its dirty and raunchy sound, as well as in its modulation potential. It has a temper and you can modulate it!

This particular delay circuit is based on the PT2399 ECHO CHIP from Princeton Technologies.

It is a slightly cleaned-up version of the well-known gritty sound of the classic delay chip, with several additions:

- a CV modulated delay time;
- an insert in the feedback loop;
- a momentary “Madness” switch to max out the feedback.

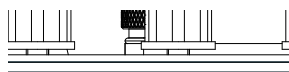
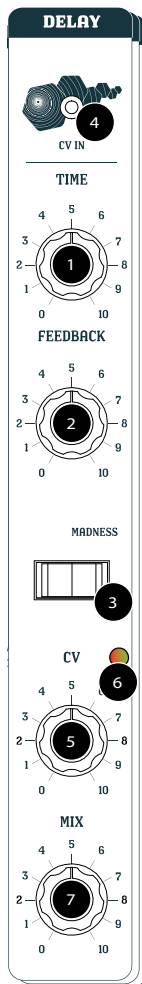

### The Dust Collector



#### 1 Time:

Sets the module's delay time.

#### Note:

When turning the unit on, the PT2399 CHIP will not always start up if the Delay Time knob is at minimum. If this happens, dial in a non-minimum value for the Time knob and restart the unit.

#### 2 Feedback:

Sets the amount of output signal to be fed back into the input.

#### 3 "Madness" switch (momentary):

Momentary switch, sets feedback to maximum for immediate delay build-ups.

#### 4 Time modulation CV input:

Input for modulating the delay's time with a CV (3.5 mm jack).

#### 5 Time CV modulation amount:

Sets the amount of modulation from the CV input (2) that will affect the delay time.

#### 6 Time CV modulation indicator:

Bi-colour LED providing visual feedback of the delay time's CV input's (6) value.

#### 7 Dry/wet mix:

Sets the balance between the input signal (dry/clean) and the output signal (wet/processed).

#### 8 Insert (back side):

The delay has an insert point in the feedback loop, allowing any effect to be inserted in order to alter the echoed sound before reinjecting it in the Delay again.



# EFFECTS

## Phaser

The Dust Collector's Phaser is based on a classic model from the 1970s and it too is designed with extensive modulation potential, using both of the LFOs, a knob and/or a CV input and even ambient light...

This model uses Light Dependent Resistors (LDR) and led's to modulate the sound. This is why the ldrs and leds were placed at the edge of the PCB, and a hole was designed in the enclosure next to the sensors.

The hole is covered with a black opaque plexi cover. When removed, the Phaser can be modulated using ambient light: move a hand in front of the hole or use any other light source and place it near the hole to modulate the effect in a new and unique way.

### 1 Feedback:

Sets the Phaser's feedback.

### 2 Modulation amount/manual depth:

Sets either the modulation amount if the Modulation selector is set on LFO 1 or LFO 2. If the selector is on Manual, it becomes the manual depth knob.

### 3 Depth bi-colour LED indicator:

Bi-colour LED providing visual feedback of the phaser's depth value: obtained by adding the modulation from LFO 1 or 2 or the manual value with the CV input's (5) value.

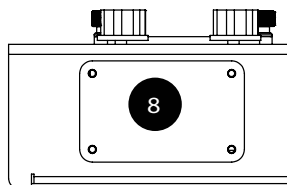
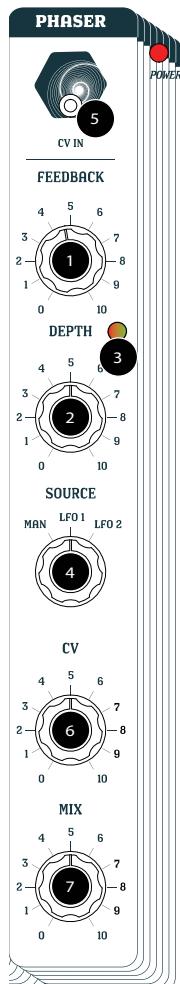

### 4 Modulation selection switch:

Sets the phaser's internal modulation mode and modulates the Phaser's depth. If either LFO is selected, the Depth (2) knob sets the modulation amount from the selected LFO.

If the switch is set on Man (manual mode), the Depth (2) knob sets the Phaser's depth, serving either as an offset for the CV modulation, or as a way to manually alter the depth, and create humanized modulations.

### 5 Depth modulation CV input:

Input for modulating the phaser's depth with a CV (3.5 mm jack). This CV value is added to the modulation set by the Depth (2) knob.

### 6 Depth CV modulation amount:

Sets the amount of modulation from the CV input (5) that will affect the phaser's depth.

### 7 Dry/wet mix:

Sets the balance between the input signal (dry/clean) and the output signal (wet/processed).

### 8 Light sensors panel (right side):

This panel can be removed to modulate the phaser with "custom" light sources and/or mechanical means in order to enhance the "movement" of the phased signal.

**DIY tip:** experiment with different coloured LEDs for (slightly) different phasing effects.



# SIGNAL PATHS

## LFOs

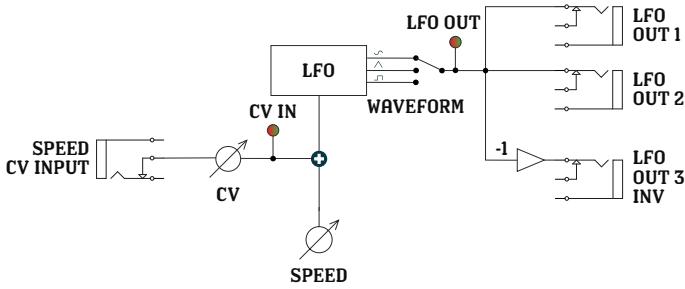

## Tape Saturations

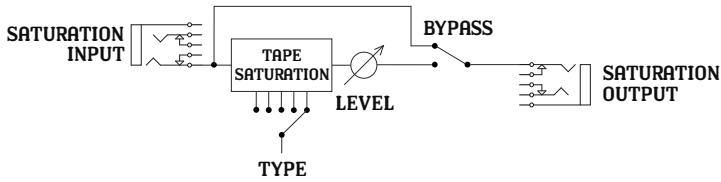

## Spring Reverb

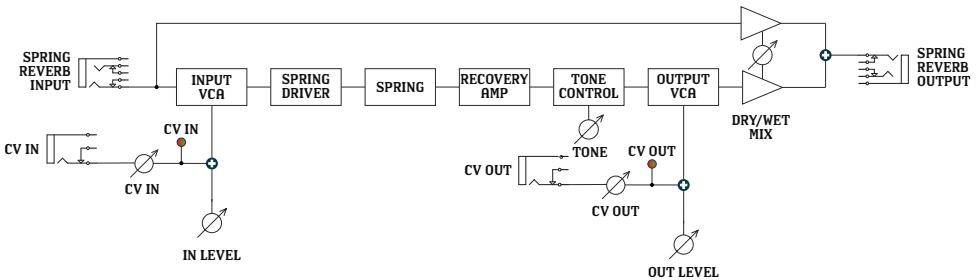

# SIGNAL PATHS

## Delay

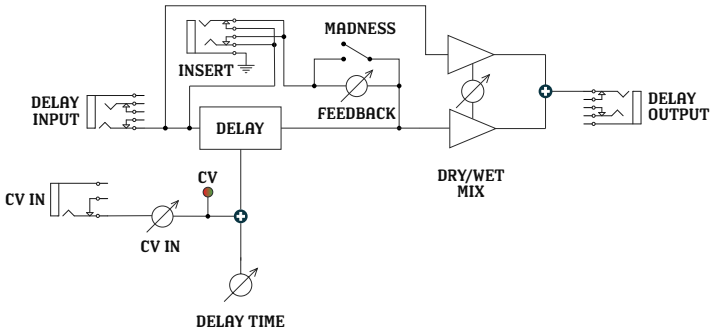

## Phaser

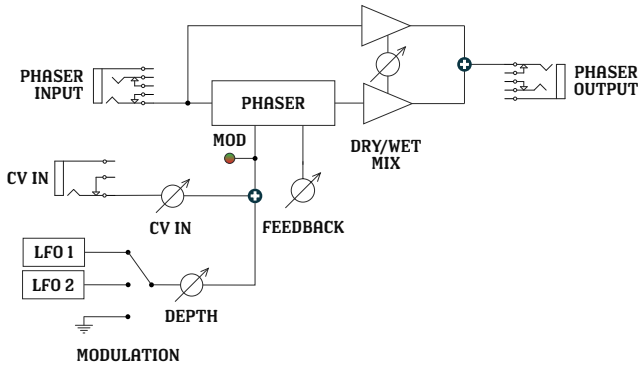

# SPECIFICATIONS

## Conventions

While playing and using *The Dust Collector*, please remember:

- ① **Bi-colour LEDs** are used to indicate certain bi-polar CV values. They are colored red and green and they are connected such that:

**RED** = negative CV voltages

**GREEN** = positive voltages.

- ① **Delay:** the insert jack is a connected type, where:

TIP = SEND

RING = RETURN.

## Technical details

- ▶ LFOs CV output range: -5V — 5V.
- ▶ Universal power supply: 24 V, 1 A, center positive supply, with a 5.5 mm diameter and 2.5 hole connector.
- ▶ Spring tank: Accutronics model **8AB2D1A**.
- ▶ Delay: based on the **PT2399** memory chip from Princeton Technologies.
- ▶ Phaser LDRs: model **5516** with yellow LEDs.

## Dimensions

- ▶ Width : 341 mm;
- ▶ Depth : 313 mm;
- ▶ Height : 57 mm (enclosure only), 70.5 mm (including the knobs);

## Weight

- ▶ 2.6 kg.



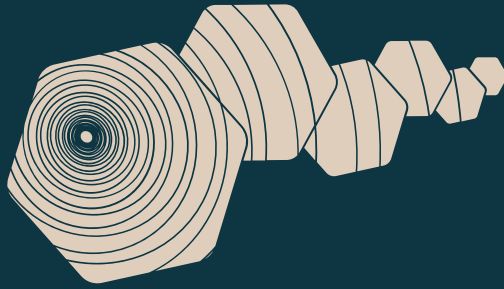

# ***The Dust Collector***

## **User's Manual**

written by  
Cristian Kreindler  
Founder, R&D

Finegear - evolving instruments

More info at

[www.finegear.net](http://www.finegear.net)

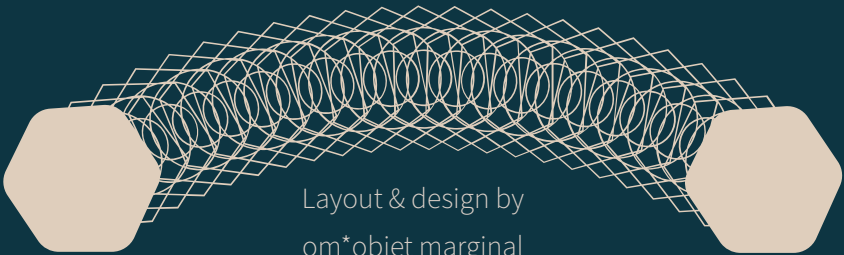

Layout & design by  
om\*objet marginal

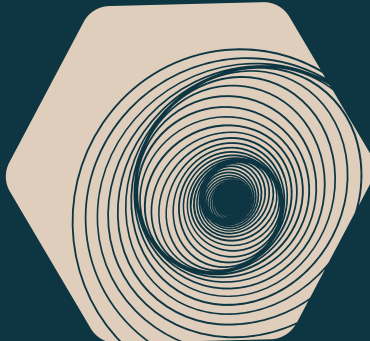

Cluj-Napoca, Romania

© June 2023